



## Introducing Window Furnishings by Flooring Xtra

Flooring Xtra is Australia's fastest-growing flooring retailer with a passion for quality products and exceptional customer service. From the floor to the windows, we provide the knowledge and expertise for homeowners to make selections they will love for years to come. The Flooring Xtra range of blinds has been specifically created to suit Australian homes at an accessible price point.

Installing blinds makes a home more comfortable and enjoyable to be in and an expertly made window blind will elevate the interior design. Made here in Australia from high-quality materials, they are ideal for the unique local conditions. They are designed to optimise light, manage privacy and improve thermal control. Achieve stunning results that will withstand time, meet trends and place the finishing touches to the look and the feel of the home.

From selections to installation, Flooring Xtra is committed to ensuring customers achieve their vision with expert advice, superior products and friendly support.



\*Photos are indicative only

- 03 Single Roller Blinds
- 05 Dual Roller Blinds
- 09 Roman Blinds
- 10 Vertical Blinds
- 11 Venetian Blinds
- 13 Shutters
- 17 Curtains
- 19 Double Curtains
- 21 Pelmet
- 24 Recommended Installation Positions
- 25 Blind Configurations
- 26 User Guide

# Single Roller Blinds

Screen, Blockout or  
Light Filtering/Translucent Fabrics



\*Photos are indicative only

## Minimum/Maximum Widths

**Minimum roller blind width** – 300mm

**Maximum roller blind width** –  
Based on supplier limitations as per pricing grid.

## Minimum/Maximum Drops

**Minimum roller blind drop** – 300mm

**Maximum roller blind drop** –  
Based on supplier limitations as per pricing grid.

## Operation

As a standard, all roller blinds are chain operated, with either a metal chain or a coloured plastic chain. The colour and type of the chain must be specified on the quote.

Flooring Xtra offers Wirefree battery motorisation as an optional extra. No electrician is required for installation. One remote will be provided per room and one charging cable will be provided for up to 5 blinds. If more than 5 motorised roller blinds, a second charger will be provided. Speak to your sales consultant for more information.

## Linking Blinds Together

Blinds can be linked together. Please speak to your consultant for further information. Please be aware light gaps will be present at each link.

## Base Bars

All roller blind base bars as standard are oval shaped. They are available in anodised aluminium, black or white. Please speak to your consultant prior to signing off on the quote to select your base bar colour.

## Chains

All single roller blinds will include a continuous metal ball chain. Chain positions will be nominated by the customer and outlined on the quote.

Chain lengths will be customised to best suit the blind and location at the measurer's discretion. If you would like to specify a chain length, please speak to your sales consultant to have it noted on your quote. Chain colour is to be selected when quoting.

## Bracket & Mechanism Colour

Flooring Xtra recommends matching the bracket and mechanism colour to the blind colour. Either black or white must be specified on the quote.

## Bracket & Tube Sizes

There are two bracket systems available. System selections are dependant on the size of your window. On larger blinds we will increase the size of the brackets from System 40 to System 45.

Please note that if the bracket size changes we will match any adjacent blinds on the same window elevation in the same room.

## Tube Size:

### SYSTEM 40:

300mm - 1979mm — **38mm tube**  
1980mm - 2429mm — **38mm HD tube**

### SYSTEM 45:

2430mm - 3000mm — **45mm tube**

## Bracket Projection:

### SYSTEM 40:

— 72mm (face fit)  
— 52mm (reveal/recess fit)

### SYSTEM 45:

— 85mm (face fit)  
— 82mm (reveal/recess fit)

A. System 40 B. System 45

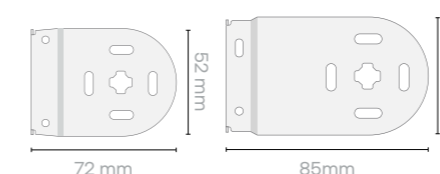

Figure 1  
Diagram showing single roller blind bracket projections in a face fit position.

## Light & Cloth Gaps

All roller blinds have visible light gaps around the sides of the fabric, even when blockout fabric is used. This is because the overall width of the blind including its brackets is always wider than the fabric width.

Gap measurements are:

- Gap on left is up to 20mm
- Gap on right is up to 20mm
- Gap between linked blinds is up to 20mm

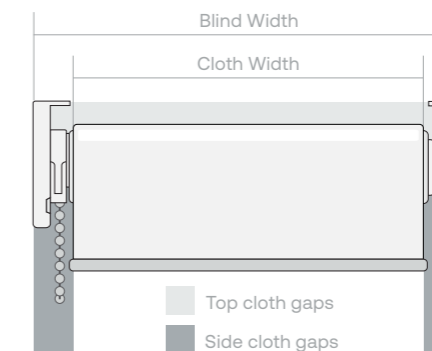

Figure 2  
Diagram showing the difference between the overall blind width (outside of bracket to outside of bracket) and the cloth width. Applicable for both single and dual roller blinds.

## Rolling Direction

Standard rolling direction is back-rolled wherever possible. "Front rolling" is a free option upon request; this is where the material rolls off the front of the roll.

Some blinds may be front rolled if there is an obstruction. If an obstruction is identified at check measure, we will seek customer sign off and adjust the quote.

## Corner Windows

On corner windows, all blinds will automatically be front rolled to reduce the light gap as much as possible. Please be aware that the light gap will still be larger for face fit blinds. All other blinds in the room will be front rolled to match.

In instances of through & butt corner windows, the through blind will be the one facing the street. When not facing the street, the larger blind will be the through blind.

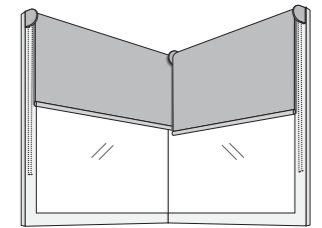

Figure 3  
Diagram showing corner window with through blind (left) & butt blind (right).

## Child Safety Devices

Child safety devices are required by law to be installed on all roller blind chains hanging below 1600mm from the floor. Chains above 1600mm are exempt. The chain must not form a loop exceeding 220mm in circumference. Flooring Xtra will install the child safety device in the most secure position.

## Window Furnishings Will Not Be Installed In These Locations

- Voids – if required, we would need to add a scaffold charge.
- Entry side light windows where the window is narrower than 250mm.
- Kitchen low light windows where there is a fire hazard or where water may be present.
- Within shower cubicles.
- Onto hinged doors - if installed onto hinged doors it will void the warranty.
- Any stair window that is unsafe to install.

## Things to Consider

- Colour variations may occur between fabric production batches. These variances are within industry tolerances.
- When windows are open, window furnishings should be in the open position to avoid stretching and distortion of the fabrics.
- As the sizes of blinds increase, there may be rippling or 'V-ing' in the fabric. This is not unexpected with larger blinds, and warranty claims will not be accepted.

# Dual Roller Blinds

## Screen & Blockout Fabrics



\*Photos are indicative only

### Minimum/Maximum Widths

**Minimum roller blind width** – 300mm  
**Maximum roller blind width** –  
 Based on supplier limitations as per pricing grid.

### Minimum/Maximum Drops

**Minimum roller blind drop** – 300mm  
**Maximum roller blind drop** –  
 Based on supplier limitations as per pricing grid.

### Operation

As a standard, all roller blinds are chain operated, with either a metal chain or a coloured plastic chain. The colour and type of the chain must be specified on the quote.

Flooring Xtra offers Wirefree battery motorisation as an optional extra. No electrician is required for installation. One remote will be provided per room and one charging cable will be provided for up to 5 blinds. If more than 5 motorised roller blinds, a second charger will be provided. Speak to your sales consultant for more information.

### Linking Blinds Together

Blinds can be linked together. Please speak to your consultant for further information. Please be aware light gaps will be present at each link.

### Base Bars

All roller blind base bars as standard are oval shaped. They are available in anodised aluminium, black or white. Please speak to your consultant prior to signing off on the quote to select your base bar colour.

### Chains

All dual roller blinds will include a continuous metal ball chain. Chain positions will be nominated by the customer and outlined on the quote.

Chain lengths will be customised to best suit the blind and location at the measurer's discretion. If you would like to specify a chain length, please speak to your sales consultant to have it noted on your quote. Chain colour is to be selected when quoting.

### Bracket & Mechanism Colour

Flooring Xtra recommends matching the bracket and mechanism colour to the blind colour. Either black or white must be specified on the quote.

### Bracket & Tube Sizes

There are two bracket systems available. System selections are dependant on the size of your window. On larger blinds we will increase the size of the brackets from System 40 to System 45.

Please note that if the bracket size changes we will match any adjacent blinds on the same window elevation in the same room.

### Tube Size:

#### SYSTEM 40 DUAL:

300mm - 1979mm — **38mm tube**  
 1980mm - 2429mm — **38mm HD tube**

#### SYSTEM 45 DUAL:

2430mm - 3000mm — **45mm tube**

### Bracket Projection:

#### SYSTEM 40 DUAL:

90mm (face and reveal/recess fit)

#### SYSTEM 45 DUAL:

106mm (face and reveal/recess fit)

#### A. System 40      B. System 45

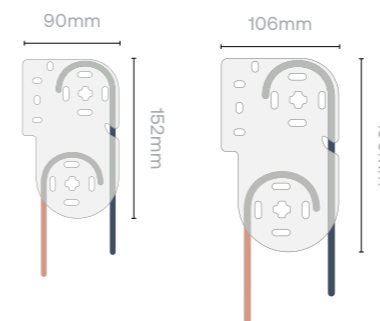

Figure 4  
 Diagram showing dual reverse bracket systems with window blind (red) and room blind (blue).

### Light & Cloth Gaps

All roller blinds have visible light gaps around the sides of the fabric, even when blackout fabric is used. This is because the overall width of the blind including its brackets is always wider than the fabric width.

Gap measurements are:

- Gap on left is up to 20mm
- Gap on right is up to 20mm
- Gap between linked blinds is up to 20mm

Refer to Figure 2 on page 4.

### Rolling Direction

There are two blinds in a dual system: 'window' and 'room' blinds. These can be explained as:

#### Window blind (red in Figure 4):

- Closest to the glass
- Always back-rolled

#### Room blind (blue in Figure 4):

- Furthest from the glass
- Always front-rolled
- It is recommended for this blind to always be the blackout

### Corner Windows

In instances of through & butt corner windows, the through blind will be the one facing the street. When not facing the street, the larger blind will be the through blind.

Refer to Figure 3 on page 4.

### Child Safety Devices

Child safety devices are required by law to be installed on all roller blind chains hanging below 1600mm from the floor. Chains above 1600mm are exempt. The chain must not form a loop exceeding 220mm in circumference. Flooring Xtra will install the child safety device in the most secure position.

### Window Furnishings Will Not Be Installed In These Locations

- Voids – if required, we would need to add a scaffold charge.
- Entry side light windows where the window is narrower than 250mm.
- Kitchen low light windows where there is a fire hazard or where water may be present.
- Within shower cubicles.
- Onto hinged doors - if installed onto hinged doors it will void the warranty.
- Any stair window that is unsafe to install.

### Things to Consider

- Colour variations may occur between fabric production batches. These variances are within industry tolerances.
- When windows are open, window furnishings should be in the open position to avoid stretching and distortion of the fabrics.
- As the sizes of blinds increase, there may be rippling or 'V-ing' in the fabric. This is not unexpected with larger blinds, and warranty claims will not be accepted.



## Roman Blinds



\*Photos are indicative only

### Minimum/Maximum Widths

**Minimum roman blind width** – 600mm  
**Maximum roman blind width** – 2600mm

### Minimum/Maximum Drops

**Minimum roman blind drop** – 600mm  
**Maximum roman blind drop** – 2900mm

### Operation

All roman blinds are fitted with manual chain operated systems.

### Chains

All roman blinds will have continuous metal ball chains. All chain positions will be nominated on the quote.

### Light Pin Holes

All roman blinds will have pin holes of light showing through the blinds wherever stitching occurs (batten pockets, side hems, and base pockets).

### Fabric Cutting

All fabrics prone to fraying are ultrasonically cut and sealed.

### Bottom Pocket

Roman blinds are fitted with a bottom bar in a 35mm pocket.

### Head Rail Projection

The head rail will project into the room by 40mm.

### Stack Height

The stack height is usually between 250 – 330mm, or the height of the first fold on your roman blind.

### Installation Position

Roman blinds should be installed as per the below for optimal window coverage. Please speak to your consultant if you would like to deviate from this.

- 250mm above the top architrave
- 20mm past the outer edge of each side architrave
- Up to 40mm below the bottom architrave

On the same elevation, romans will be installed at the same height unless the height difference between the windows/ sliding doors is greater than 200mm.

### Child Safety Devices

Child safety devices are required by law to be installed on all roman blind chains hanging below 1600mm from the floor. Chains above 1600mm are exempt. The chain must not form a loop exceeding 220mm in circumference. Flooring Xtra will install the child safety device in the most secure position.

### Panel Spacing & Line Up

Panel spacing will vary according to the drop of your roman blind. These will be automatically calculated by the Flooring Xtra team. If you have more than one roman blind in a room with varying drops, Flooring Xtra will automatically line up the spacing for you. This may result in your bottom panels being different sizes to each other.

### Window Furnishings Will Not Be Installed In These Locations

- Voids – if required, we would need to add a scaffold charge.
- Entry side light windows where the window is narrower than 250mm.
- Kitchen low light windows where there is a fire hazard or where water may be present.
- Within shower cubicles.
- Onto hinged doors - if installed onto hinged doors it will void the warranty.
- Any stair window that is unsafe to install.

### Things to Consider

- Colour variations may occur between fabric production batches. These variances are within industry tolerances.
- When windows are open, window furnishings should be in the open position to avoid stretching and distortion of the fabrics.

## Vertical Blinds

### Blockout Fabrics

### Minimum/Maximum Widths

**Minimum vertical blind width** – 600mm  
**Maximum vertical blind width** – 6000mm

### Minimum/Maximum Drops

**Minimum vertical blind drop** – 600mm  
**Maximum vertical blind drop** – 3300mm

### Blade Width

Blade width – 89mm or 127mm

### Operation

Tilt control and stack control is by way of wand only. Verticals stacking to one side will have controls on the stack side.

### Track

The track colour for vertical blinds must be specified on the quote. Speak to your sales consultant for further information.

### Fabrics

Vertical blinds are manufactured in Category 1 – blockout fabrics only.

### Bottom Weights

All vertical blinds will have chain-less bottom weights.

### Opening Direction

Vertical blinds can be one way draw, centre opening or centre stacking. For vertical blinds installed to sliding doors, we recommend following the same opening direction as the door. Opening direction must be specified on the quote.

### Window Furnishings Will Not Be Installed In These Locations

- Voids – if required, we would need to add a scaffold charge.
- Entry side light windows where the window is narrower than 250mm.
- Kitchen low light windows where there is a fire hazard or where water may be present.
- Within shower cubicles.
- Onto hinged doors - if installed onto hinged doors it will void the warranty.
- Any stair window that is unsafe to install.

### Things to Consider

- Colour variations may occur between fabric production batches. These variances are within industry tolerances.
- When windows are open, window furnishings should be in the open position to avoid stretching and distortion of the fabrics.



\*Photos are indicative only

# Venetian Blinds

## Aluminum



\*Photos are indicative only

### Minimum/Maximum Widths

**Minimum venetian blind width** – 250mm  
**Maximum venetian blind width** – 2400mm

### Minimum/Maximum Drops

**Minimum venetian blind drop** – 300mm  
**Maximum venetian blind drop** – 2700mm

### Blade Width

Blade width – 25mm

### Operation

All aluminium venetian blinds come with a lift cord and a tilt wand.

### Head Rail Projection

The head rail is 25mm x 25mm and is coordinated to your blade colour selection.

### Bottom Rail

Made from a C-shaped 22.5mm x 10mm lock seamed tubular section.

### Tilt Rod

All tilt rods are clear plastic PVC.

### Cord Colour

Coordinated with blade colour.

### Cord Lock & Cleat

Aluminium venetian blinds come with a cord lock and a clear plastic cleat to wrap the cord around. The control side must be selected by the customer and identified on the quote.

### Blade Overlap

This is the amount that each blade covers the preceding blade:  
 25mm aluminium venetian blinds – 5mm.

### Hold Down Clips

Flooring Xtra will not supply or install hold down clips.

### Sliding Doors

Flooring Xtra will not install aluminium venetian blinds to sliding doors.

### Window Furnishings Will Not Be Installed In These Locations

- Voids – if required, we would need to add a scaffold charge.
- Entry side light windows where the window is narrower than 250mm.
- Kitchen low light windows where there is a fire hazard or where water may be present.
- Within shower cubicles.
- Onto hinged doors - if installed onto hinged doors it will void the warranty.
- Any stair window that is unsafe to install.

### Things to Consider

- Colour variations may occur between fabric production batches. These variances are within industry tolerances.
- When windows are open, window furnishings should be in the open position to avoid damage.

# Venetian Blinds

## PVC



\*Photos are indicative only

### Minimum/Maximum Widths

**Minimum venetian blind width** – 300mm  
**Maximum venetian blind width** – 2400mm

### Minimum/Maximum Drops

**Minimum venetian blind drop** – 300mm  
**Maximum venetian blind drop** – 2600mm

Blinds narrower than 450mm will have tilt control and lift control on opposite ends of blind.

### Blade Width

Blade width – 50mm

### Operation

All PVC venetian blinds come with a lift cord and two tilt cords.

### Head Rail Projection

The head rail is 57mm x 54mm and is coordinated to your blade colour selection.

### Bottom Rail

The bottom rail is 48mm x 12mm and is coordinated to your blade colour selection.

### Fascia

All PVC venetian blinds come with a fascia to cover the head box. PVC venetian blind fascias are 100mm high. These are coordinated to your blade colour selection. Fascia returns are automatically included on all blinds that are face fitted.

### Cord Colour

Matched to blade colour.

### Cord Lock & Cleat

All PVC venetian blinds come standard with cord lock and a clear plastic cleat to wrap the cord around.

### Safe Product Use

Before raising blinds, please ensure that blades are in the open (horizontal) position.

### Sliding Doors

Flooring Xtra will not install PVC venetian blinds to sliding doors.

### Window Furnishings Will Not Be Installed In These Locations

- Voids – if required, we would need to add a scaffold charge.
- Entry side light windows where the window is narrower than 250mm.
- Kitchen low light windows where there is a fire hazard or where water may be present.
- Within shower cubicles.
- Onto hinged doors - if installed onto hinged doors it will void the warranty.
- Any stair window that is unsafe to install.

### Things to Consider

- Colour variations may occur between fabric production batches. These variances are within industry tolerances.
- When windows are open, window furnishings should be in the open position to avoid damage.
- PVC venetian blinds can be heavy to lift. This is standard and there are no options to assist with the weight. Ideally, this blind should be selected for a window where you most commonly will tilt the blades to control light, and only require lifting infrequently (eg. routine cleaning).

# Shutters

## Range Selection

### CAT 1 WOODLORE

Woodlore shutters are made out of engineered wood composite with a medical grade polypropylene coating for durability. They are manufactured from a combination of timber fibres and glue, and are dimensionally very stable. Used worldwide in the manufacture of furniture, the material lends itself very well to the manufacture of shutters. This product is suitable for dry areas only.

### CAT 2 WOODLORE PLUS WATERPROOF

Woodlore Plus Waterproof shutters are made from ABS, the same product used to manufacture Lego. Woodlore Plus shutters are waterproof and suitable for wet areas.

### CAT 3 NORMANDY

Normandy shutters are made from Phoenixwood, from the Phoenix Tree (Firmiana Simplex) which is classed as a hardwood, and comes from the Sterculiaceae (Cacao) family of trees. This product is suitable for dry areas only.

## Operation

Shutters installed to a window will be hinged and include functional panels and tiltable blades. Shutters installed within a void will be fixed in place and only the blades will tilt.

## Sliding Doors

Flooring Xtra will not install shutters to hinged or sliding doors.

## Projection

To fit shutters within a window reveal, we require 70mm internal clearance. The shutter blades will still protrude into the room when in the open position. Please take note of any window winders or obstructions that may impede the shutter

## Hinges

All hinge colours are determined depending on the shutter colour requested. This is completed by Flooring Xtra and will be matched to the closest colour to the shutter selected. With the exception of Woodlore Plus Waterproof shutters – these will always include stainless steel hinges, suitable for wet areas.

## Flyscreens

When selecting the mounting position with your sales consultant: Please consider if fly-screens will be added to the window in the future, as there may not be enough space if reveal mount is selected..

## Obstructions

All windows are different, and therefore there may be some obstructions such as window winders, mullions, or transom bars. Flooring Xtra's installers will determine any obstructions at their check measure.

## Frame Type

Flooring Xtra offers two frame options, Z frame and L frame. It is possible to do either with 3 sides if there are obstructions. Speak to your sales consultant to discuss which option suits your windows.

## Panel Layout

The panel layout must be specified on the quote. If an obstruction is identified at check measure, we will seek customer sign off and adjust the quote.

## Midrails

For larger shutters, midrails assist with the integrity of the panels and prevent them from sagging. If the drop of your window is greater than 1520mm, a midrail is required. If more than 2032mm, you'll require two midrails. Midrails are also required if there are window winders.

## Window Furnishings Will Not Be Installed In These Locations

- Voids – if required, we would need to add a scaffold charge.
- Entry side light windows where the window is narrower than 250mm.
- Kitchen low light windows where there is a fire hazard or where water may be present.
- Within shower cubicles.
- Onto hinged doors - if installed onto hinged doors it will void the warranty.
- Any stair window that is unsafe to install.

## Things to Consider

- Colour variations may occur between fabric production batches. These variances are within industry tolerances.
- When windows are open, window furnishings should be in the open position to avoid damage.

## Specifications

Product Name	CAT1 Woodlore	CAT 2 Woodlore Plus	CAT3 Normandy
Material Type	Engineered Wood Composite	ABS (Waterproof)	Phoenixwood
Stile Profile	Chamfer Beaded	Chamfer Beaded	Chamfer Beaded
Louvre Type	Elliptical	Elliptical	Elliptical
Louvre Width	89mm	89mm	89mm
Maximum Panel Height	2700mm	3000mm	3000mm
Divider Rail Required For Panel Heights Over	1879mm	1800mm	1981mm
Tilt Rod	Easy Tilt	Easy Tilt	Easy Tilt
Maximum Panel Width (mm)	914mm	920mm	1095mm
Split Operation	Approx. 1350mm	Approx. 1350mm	Approx. 1350mm
Suitable For	Dry Areas Only	Dry & Wet Areas	Dry Areas Only
Hinge Colour	Matched to Shutter Colour	Stainless Steel Only	Matched to Shutter Colour

\*Photos are indicative only



# Shutters

## Configurations

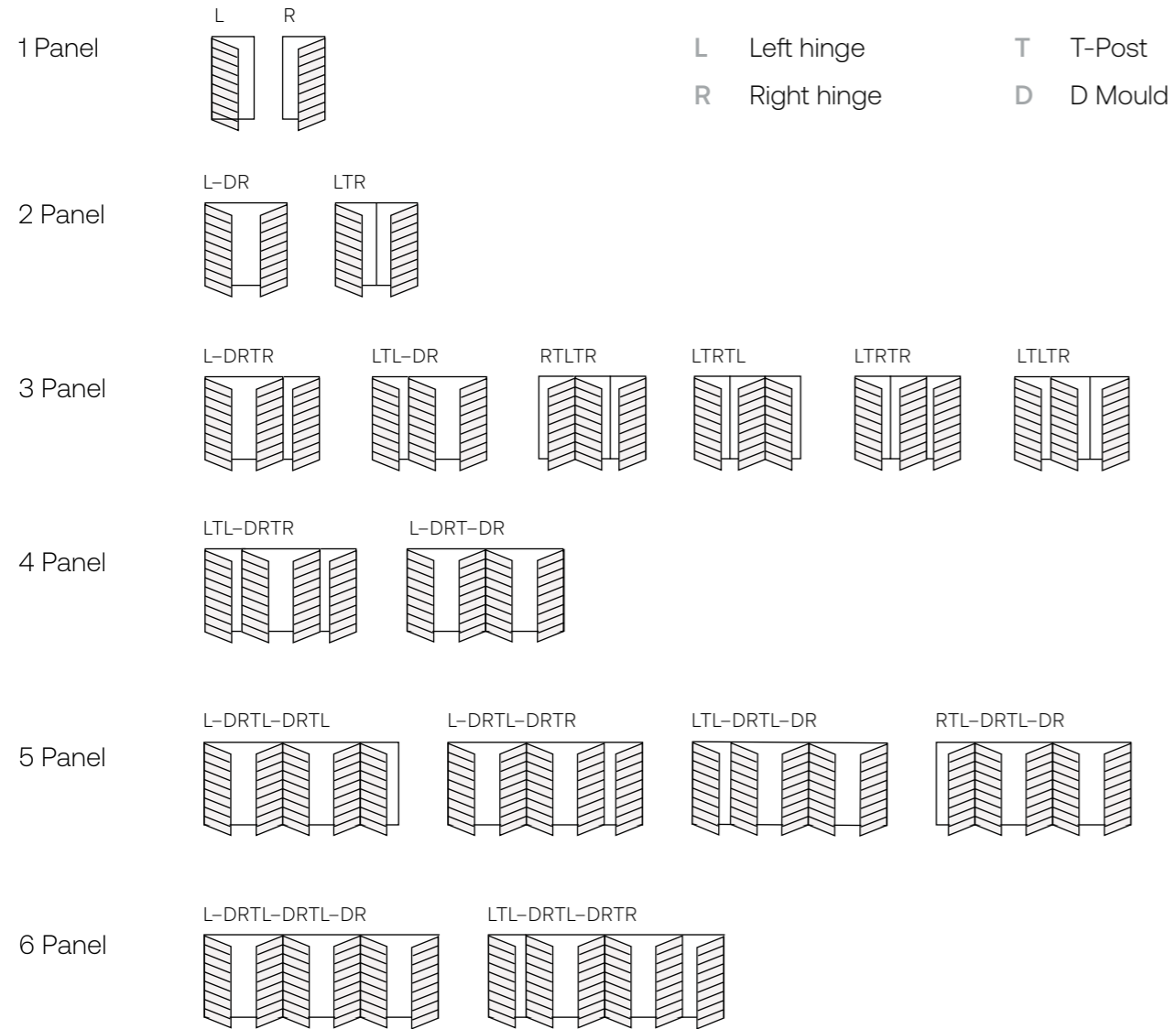

Please Note:  
 These variations can be flipped left or right.

# Shutters

## Anatomy

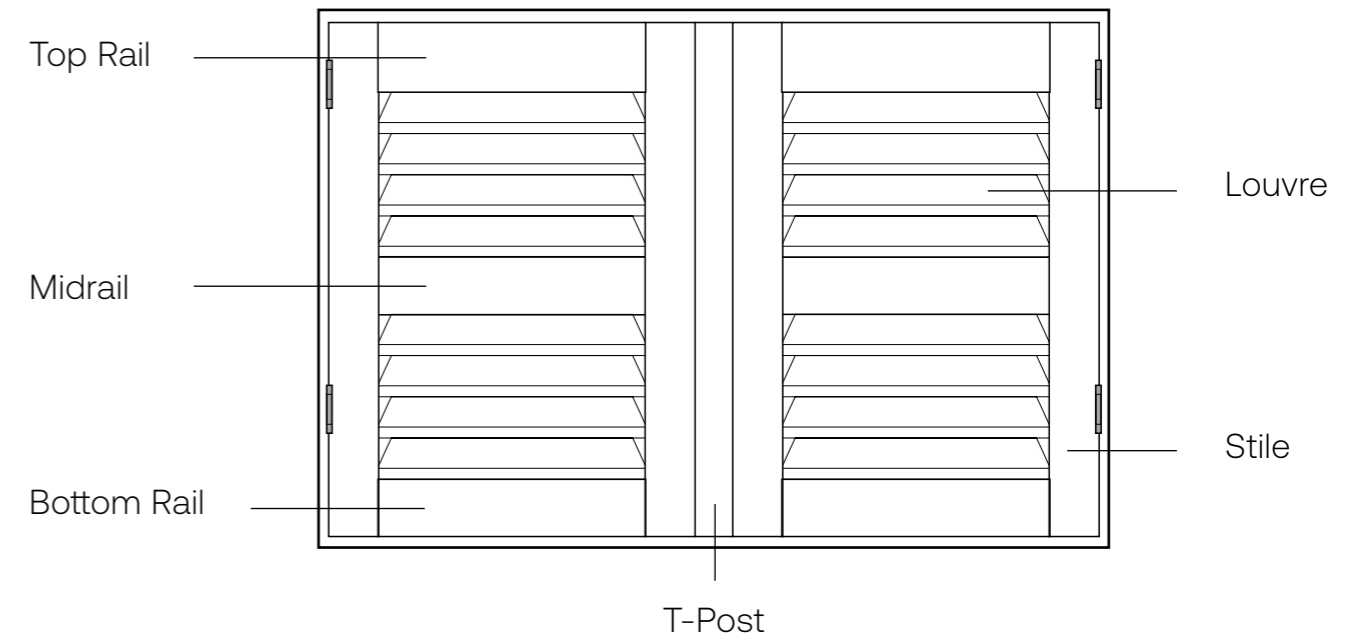

# Curtains

## Pencil Pleat & S-Fold

### Minimum Width/Maximum Drop

**Minimum width** — 300mm

**Maximum drop** — based on supplier limitations as per pricing grid.

### Operation

All curtains are operated with a flick stick that is suitable for sheers and blackout fabrics. Curtains can be configured to open as centre opening, 1 piece free flow, 2 piece free flow or one way draw. Flick stick quantities will automatically match curtain configuration.

### Fabrics

Our curtains can be manufactured from any fabrics from our Flooring Xtra range, which includes both sheer and blackout options.

### Stitch Lines

On self coated curtain fabrics there will likely be visible stitch lines that may allow pin holes of light through.

### Fullness

Fullness of the curtain will change depending on curtain heading type selected. All selections will match the industry standards.

### Lining

All blackout curtains that are self-coated will NOT have a lining. All dim out curtains will include an ivory blackout lining.

### Hems

All sheer fabrics will come with a weighted hem. All blackout fabrics will be manufactured with an 80mm double turned hem.

### Returns

A return is where the end of the curtain at each side is made a little longer to allow it to return back to the wall.

Flooring Xtra recommends using returns, however they are not required.

### Side Stack

This is the space a curtain occupies on the left or right side of your window when it is open. As a rule, assume the side stack is equal to a third of the curtain width.

Please note that the curtain stack may protrude into the window opening.

### Track Installation Options

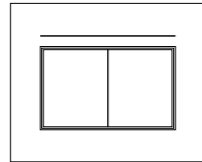

**Standard**  
150mm above the architrave.

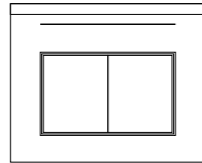

**Below Cornice**  
50mm below cornice.

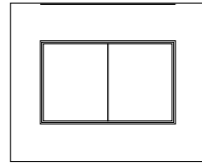

**Ceiling Mount**  
Installed onto the ceiling. Only when ceilings are square set.



**Customised Track Installation\***

\*To customise your curtain track installation position, please speak with your consultant.

#### Please Note:

Flooring Xtra does not offer curved tracks.

### Raked or Pitched Ceilings

For raked or pitched ceiling the track will always be horizontal to the floor.

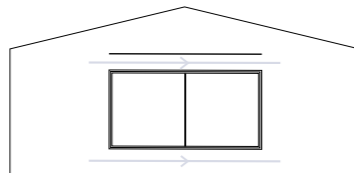

### Curtain Width Options

We have the following curtain width options:

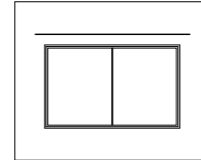

**Standard**  
Curtain will be manufactured to sit 100mm past each vertical architrave.

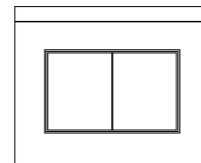

**Wall to Wall**  
When the curtain is installed over the full width of the wall from corner to corner.

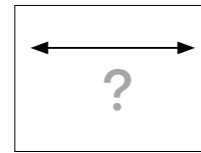

**Customised Width**  
To customise your wall width, please speak with your consultant.

### Curtains & Pelmet

If a pelmet accompanies the curtain, the curtain will be brought down to reside within the pelmet. The curtain track will be standard width (window width + 200mm).

Pelmets will be installed 50mm above the architrave and are 50mm wider than the overall width of the curtain.

For existing pelmets, the mounting position will be confirmed upon check measure.

### Things to Consider

- Colour variations may occur between fabric production batches. These variances are within industry tolerances.
- When windows are open, window furnishings should be in the open position to avoid stretching and distortion of the fabrics.
- All curtains will sit approximately 10mm off the floor. Fabrics can be affected by atmospheric conditions and some movement is acceptable. The industry standard is 3% movement up or down.



## Pencil Pleat Specifications

### Heading & Heading Tape

Pencil pleat curtains will have 75mm heading tape.

### Track

Pencil pleat curtains will be installed on a non-decorative track with runners and plain end caps.



\*Photos are indicative only

## S-Fold Specifications

### Heading & Heading Tape

Flooring Xtra manufactures S-fold curtains using hook tape for both blackout and sheer fabrics.

### Track

S-fold curtains will be installed on a 25mm decorative track with runners and plain end caps.

There is an option for non-decorative track with runners and plain end caps. This option is suitable for ceiling mounted tracks in rooms where ceilings are square set or underneath a pelmet.

## Double Curtains

Pencil Pleat & S-Fold



\*Photos are indicative only

### Double Curtain Track Options

We are able to supply double curtains with the below options:

#### WINDOW FURNISHING

- Pencil pleat heading

#### ROOM FURNISHING

- Pencil pleat heading
- OR
- S-fold heading

#### Please Note:

- 'Window' furnishing is the curtain installed closest to the glass.
- 'Room' furnishing is the curtain installed furthest from the window, into the room. This will be the heading visible inside the room.
- In the case of a pencil pleat and S-fold selection, the S-fold will always be the room furnishing.
- Fabric placement will be confirmed by client with assistance from your consultant.
- Projection of tracks is approximately 200mm into the room.
- Double S-fold curtains on the same window are not available



# Pelmets

## Soft

### Minimum/Maximum Widths

**Maximum pelmet width** – 3900mm

**Minimum pelmet width** – 300mm

### Pelmet Height

Pelmet height is 200mm.

### Fabrics

Soft pelmets are manufactured from our Flooring Xtra blackout curtain fabrics.

### Fabric Joins

Depending on the width of the pelmet and the fabric you select, vertical fabric joins may be present. If vertical joins are required, we will manufacture your pelmet with two joins spaced apart, rather than one central join.

### Returns

Returns can be provided upon request free of charge in any of the below configurations:

- Both
- Left Only
- Right Only
- No Returns

The above must be specified on the quote.

### Installation

Pelmets will be installed 50mm above the architrave. Pelmets will be installed 25mm beyond the outside edges of the architraves.

If a pelmet accompanies a curtain, the curtain will be brought down to reside within the pelmet that will be installed 50mm above the architrave. The pelmet will then be 50mm wider than the overall width of the curtain.

The overall width of the curtain equals window width + 200mm (standard width).

### Pelmet Projections

Pelmet projections are determined by the amount of furnishings being installed to the window or sliding door:

- Without furnishing/or blind installed into recess: 75mm
- With 1 x furnishing installed within the pelmet: 100mm
- With 2 x furnishings installed within the pelmet: 200mm

### Window Furnishings Will Not Be Installed In These Locations

- Voids – if required, we would need to add a scaffold charge.
- Entry side light windows where the window is narrower than 250mm.
- Kitchen low light windows where there is a fire hazard or where water may be present.
- Within shower cubicles.
- Onto hinged doors - if installed onto hinged doors it will void the warranty.
- Any stair window that is unsafe to install.



\*Photos are indicative only



## Recommended Installation Positions

	Windows	Sliding Doors	Opening/Cut outs
Single Roller Blinds	Reveal/Recess or Face Fit	Face Fit Only	N/A
Dual Roller Blinds	Reveal/Recess or Face Fit	Face Fit Only	N/A
Roman Blinds	Face fit only 150mm above architrave, 20mm past each vertical architrave, and up to 40mm below the bottom architrave	Face fit only 150mm above architrave, 20mm past each vertical architrave, and will sit 10mm above floor	N/A
Venetian Blinds	Reveal/Recess	N/A	N/A
Shutters	Reveal/Recess or Face Fit	N/A	Fixed in U-Channels
Curtains	Face fit only 150mm above architrave, 100mm past each vertical architrave and 10mm above floor	Face fit only 150mm above architrave, 100mm past each vertical architrave and 10mm above floor	N/A
Pelmets	Face fit only 50mm above architrave, 25mm past each vertical architrave	Face fit only 50mm above architrave, 25mm past each vertical architrave	N/A
Vertical Blinds	Reveal/Recess or Face Fit	Face Fit Only	N/A

**Please Note:**

Standard installation positions will be as per the table above, unless noted otherwise on your quote. If there is an obstruction on your windows, furnishings may be reveal or face fitted at Flooring Xtra's discretion at the time of site check measure. Please note: Window furnishings installed in the reveal of the window may restrict install and/or removal of flyscreens.

# Blind Configurations

## Flooring Xtra Suggestions

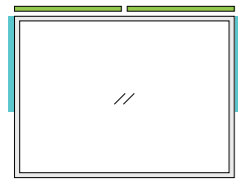

### No Mullion

Whenever there are no mullions, Flooring Xtra suggest splitting blinds in the middle over the glass.

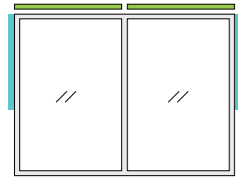

### 1 Mullion

Whenever there is 1 mullion, Flooring Xtra suggests splitting into 2 blinds.

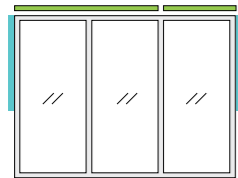

### 2 Mullions

When there are 2 mullions present, Flooring Xtra suggests splitting windows 2/3, 1/3 split to lower the cost for clients.

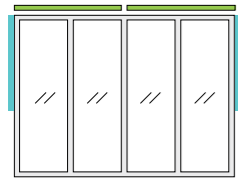

### 3 Mullions

When there are 3 mullions present, Flooring Xtra suggests splitting windows into 2 blinds or 4, depending on the overall width of the window.



2700mm wide window

2700mm wide Roller Blinds are only recommended on highlight windows.

Flooring Xtra can manufacture and install them to full height windows and sliding doors, however consumers should be aware that this product will not be warranted by Flooring Xtra due to potential rippling of fabric and general performance issues.

- Blinds
- Chains
- Link required

# Blind Configurations

## Flooring Xtra Suggestions

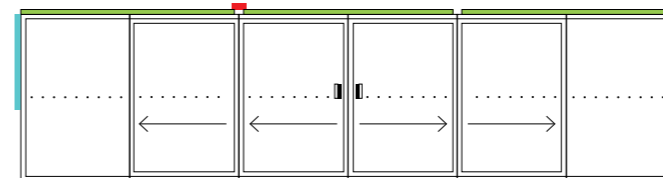
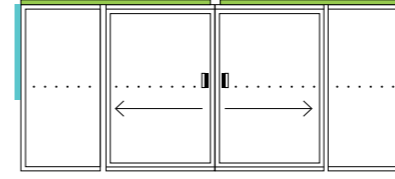
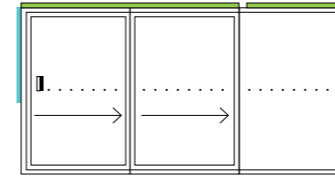
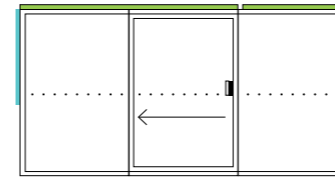
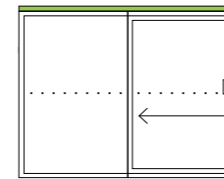

- Blinds
- Chains
- Link required

## Flooring Xtra Suggestions

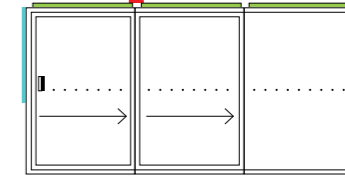
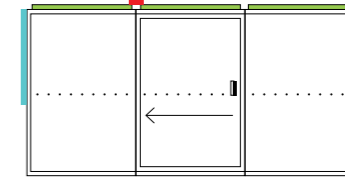
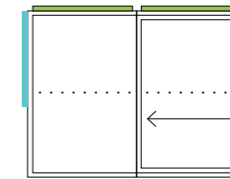

Standard Linkage  
1 x bracket

or

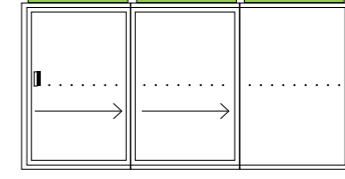

Alternate Linkage  
2 x brackets, must be noted on quote

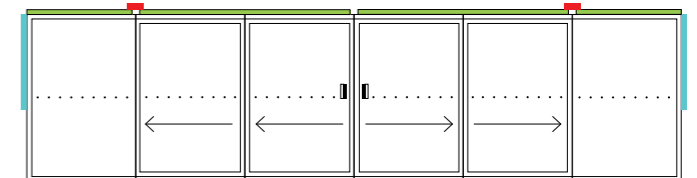

# User Guide

## Cleaning & Maintenance

### Care & Cleaning

All window furnishings require some regular cleaning and maintenance in order to preserve their integrity. In all cases, the cleaning process should first be tested in an inconspicuous area.

Generally, surface dust may be removed with a gentle brush, feather duster or clean, dry cloth and wiped with a dry sponge. However, each window furnishing will have slightly different instructions.

#### STAIN REMOVAL

To remove wet embedded stains, sponge blind clean with a damp cloth. Use a small amount of diluted washing liquid in warm water and avoid rubbing the stain. Do not immerse blinds in water. Do not use this method with timber window furnishings – use ammonium free general use spray, spraying onto a cloth first and then wipe onto surface.

#### SPOT CLEANING

Small dry marks may be rubbed off quite effectively with a gum-based eraser (available in most art supply stores). If this fails, use the method described in the paragraph above

#### MOULD PREVENTION

Many fabrics are treated with mould repelling agents, however under certain conditions even these preventative agents can prove ineffective. High levels of humidity inside your house can lead to mould growth on any surface, including your blinds. Mould is most commonly found in areas such as bathrooms, but any room could have a humidity problem.

When the warm air inside your home comes in contact with the cold glass of your window, condensation can occur. This can trap a layer of moisture between your windows and your blinds over time, and may lead to the growth of mould. Proper ventilation is the simplest way to reduce humidity levels. However where this is not possible, installing a de-humidifier will assist.

### Roller & Roman Blinds

Most roman and roller blinds simply require regular vacuuming (with an upholstery attachment) in order to keep them in top condition. Do not oil any part or mechanism of the blind, as the oil may get on the fabric and damage it permanently.

### Aluminium Venetian Blinds

To clean the slats of venetian blinds, we recommend the use of a clean anti-static duster or cloth. For stubborn stains we recommend you wash your blinds with a mild detergent, and thoroughly rinse with clean water. Dry thoroughly before re-hanging. Do not use harsh abrasive or solvent based chemicals as these cause irreparable damage to your blind.

### PVC Venetian Blinds

Cleaning venetians may be done with the soft brush of a vacuum cleaner or feather duster. Do not use a damp or wet cloth. Do not use silicone-based products for cleaning. Dust blinds frequently to avoid dust build up.

### Engineered Composite Wood & ABS

We recommend regular dusting of shutters for dust build up, with a soft dust brush or soft microfibre cloth.

You can use a mild detergent with a soft cloth to wipe each shutter blade clean. Do not use a kitchen cleaner e.g. Ajax or a scouring pad, as this can permanently damage the shutters.

### Timber Plantation Shutters

We recommend regular dusting of shutters for dust build up, with a soft dust brush or soft microfibre cloth. If shutters are a natural timber, you may need to use a soft cloth and a non-wax polish.

Avoid using water or other liquid methods as this can damage the timber and could lead to warping or bowing. If there are stubborn stains, we recommend using an ammonium-free general use spray: spray onto cloth first and then wipe onto surface.

### Curtains & Pelmets

It is important to vacuum your curtains regularly with the appropriate attachment. This will prevent dust from accumulating and gradually becoming embedded in the fabric.

If curtains require cleaning, please follow cleaning instructions according to the care label attached to the product. Remove all hooks, and in the case of pencil or gathered headings, loosen the drawstrings (but do not remove).

Always allow for 3% shrinkage with dry cleaning. It is recommended that matching items be cleaned together. Remove all spills immediately using a clean damp cloth. Do not rub or soak the fabric but dab gently.

### Wirefree Automation

Surface dust may be removed with a gentle brush, feather duster or clean, dry cloth and wiped with a dry sponge. To remove any small marks, use a gum-based eraser.

# User Guide

## Operation Instructions

### Single & Dual Roller Blinds

Roller blinds are finished without side hems and have ultrasonically sealed edges. Please ensure that the blind rolls up and down straightly by raising and lowering the blind with moderate speed. Avoid letting the chain rub on the edge of the fabric as this can result in fraying of the fabric.

Do not pull on the fabric to operate the blind, use the chain provided. Ensure that you never unroll the total length of fabric from the roller.

When rolling your blind up or down, the chain should be held in a vertical position. Avoid using excessive force when operating the blind, as this may cause damage to the chain mechanism and/or the fabric.

Following these steps will ensure that:

- The fabric is not damaged
- The amount of noise is limited when operating the blind
- The blind will lift evenly

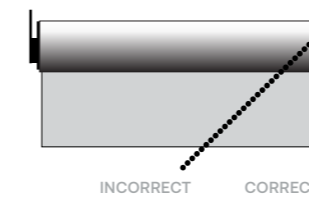

Figure 1  
Schematic diagram showing the correct and incorrect orientation to hold your chain when rolling your blind up or down.

### Roman Blinds

Roman blind operation is with a chain, as per the roller blind. Do not pull on the fabric to operate the roman, use the chain provided. Avoid letting the chain rub on the edge of the fabric of the roman blind.

The cleat will be installed 1600mm or more above floor level. Flooring Xtra will fit a child safety device in the most secure position.

### Aluminium Venetian Blinds

Before raising the blinds, always ensure that the slats are tilted fully open. When opening the window behind the blind, always raise the blind first. Pushing your hand through the slats will cause unnecessary wear and tear on your blind.

### Timber Shutters

Ensuring your hands are clean, you can just grab lightly any of the timber blades to open the shutter. Please ensure that there are no obstructions that may hit and damage a blade, i.e. a key lock for a window, or a window winder.

### Curtains & Pelmets

Keep curtain track and rod channels free of dust. Always use the flick stick to operate.

# User Guide

## Wirefree Automation

### Pair Remote Controls

In the event your remote needs to be re-paired with your blinds, follow the below instructions.

- Briefly press the remote “up” and “down” buttons simultaneously.
- The blind will briefly move Up and Down to confirm pairing.

### Setting Bottom Limit

The bottom limit refers to where the blind will stop when the “up” or “down” buttons have been pressed.

#### **THE UP LIMIT**

---

- Press and hold the ‘UP’ button to move the blind to the desired ‘UP’ position. If necessary, adjust the ‘UP’ position using the ‘UP’ or ‘DOWN’ buttons.
- To set the ‘UP’ limit, press the ‘MY’ and ‘DOWN’ buttons simultaneously and release once the blind begins to move.
- The ‘UP’ limit is now set
- Press the ‘MY’ button when the blind reaches the desired down position. If necessary, adjust the down position using the ‘UP’ or ‘DOWN’ buttons.

#### **THE DOWN LIMIT**

---

- Press the ‘MY’ button and ‘UP’ buttons simultaneously and release when the blind begins to move.
- The Down limit is now set
- To test and complete limit programming, press and hold the ‘MY’ button until the blind briefly moves up and down. The end limits are now set.

### Recharging Your Motorised Blinds

Over time your Wirefree blind may start to roll much slower when moving both up and down, or stop altogether. This may indicate it is time to charge your motorised blinds.

To charge the battery, connect the charger to the charging port located on the motor control end of the blind.

The LED on the charger will illuminate as below:

- Solid Red = Charging
- Solid Orange = Charging is near completion
- Solid Green = Charging is complete

When charging is complete, disconnect and store charger for later use.

### “My” Favourite Setting

Wirefree blinds have the option to have a saved favourite height, to set this up, follow the below instructions.

#### **SETTING UP “MY” FAVOURITE FOR MOTORISED ROLLER BLINDS**

---

- Move the blind to the desired position using the UP or DOWN button on the remote.
- Press and hold the MY button until the blind moves Up and Down.

#### **MODIFYING “MY” FAVOURITE FOR MOTORISED BLINDS**

---

- Use the UP or Down button to move the blind to the new desired position
- Press the My button to stop the blind
- Press and hold the MY button until the blind briefly moves Up and Down.

# User Guide

## Safety & Warranty

### Safety Instructions

#### **WARNING:**

---

Young children can strangle themselves in the loop of chains and cords that run through window coverings. To avoid strangulation and entanglement keep cords out of reach of young children.

### Warranty Statement

Flooring Xtra warrants each window furnishing that is sold and delivered, to be free of defects in material and workmanship under normal use and conditions for a period of 12 months. Please note that this 12 month period begins from the date of installation.

Flooring Xtra will replace any window furnishing that proves defective within the limits of this warranty.

Warranty does not apply to any product that has been subject to misuse, negligence, accidental damage or improper maintenance.

#### **PLEASE NOTE**

---

Each product has been manufactured with the highest quality materials, however some colour fading and shrinkage (up to 2%) is completely normal and should be expected during the lifetime of the blind. Flooring Xtra will not warrant a blind narrower than 300mm in width.



**National**

Phone 1300 356 679

[flooringxtra.com.au](http://flooringxtra.com.au)

**Follow us**

[@flooringxtra\\_au](https://www.instagram.com/flooringxtra_au)

Version 2.0

FLOORING  TRA